



YARRA RIDGE



Operation: An all-metal lock for sliding glass doors. Once the door is closed, the twin beaks are operated by key or lever to engage the catch plate.

Special Features:

- **Twin counteracting beaks** engage an all-metal catch plate, providing resistance to jemmying and restraining the door against being lifted from its rails.
- **Increased knuckle clearance to operate key:** The lock cylinder is set 37mm from door-jamb when door is closed.
- **Self-adjusting catch plate** automatically compensates for building movement and door carriage wear, to ensure correct latching after continued use.
- **A range of outer pull designs** is available for various applications.
- **Anti-slam plunger** prevents the door being shut with beaks extended, avoiding damage to beaks and catch plate. Beaks can only be extended when the door is closed.
- **Australian** design and manufacture.
- Subject to patenting.

Egress Version: Where the occupant can always operate the lever to exit without the need for a key.

Multipoint: Yarra Ridge may be connected to the **Vent Lock kit** which provides remote locking and vent locking.

Installation Features:

- **Drop-in cylinders** can be easily fitted during lock installation.
- **Surface mounted** using the industry standard three holes.
- Fits door frames from 21.3mm to 46.4mm thick.
- **Symmetrical design** of Yarra Ridge suits left-closing and right-closing doors. This also makes the Yarra Ridge suitable for locking double doors.
- **Fitting instructions** can be downloaded from www.ausloc.com

Finishes: Available in Satin Chrome, Bright Chrome, Bright Gold and in the range of powder coated finishes shown in Section 10 of this catalogue. Finishes include PSIL (powder-coated Satin Chrome look-alike) that is more suitable for coastal and high humidity environments.

- Keying:**
- 5-pin and 6-pin cylinders are available
 - C4 or Gainsborough compatible keyways
 - can be keyed alike

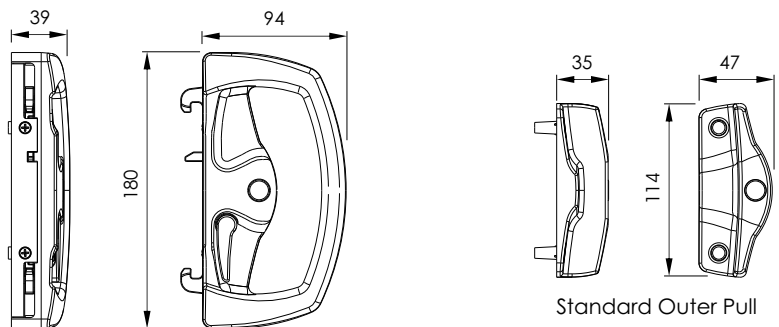

Standard "D" Inner Pull

Standard Outer Pull

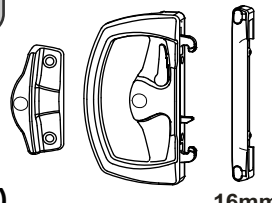
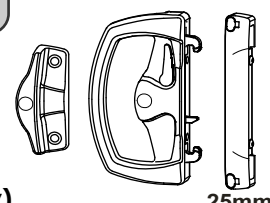
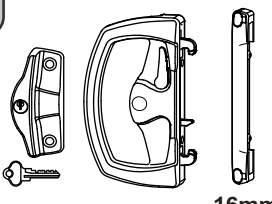
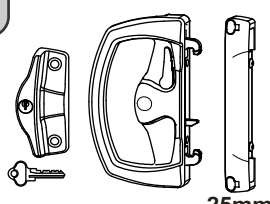
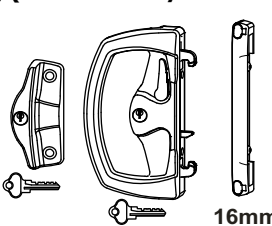
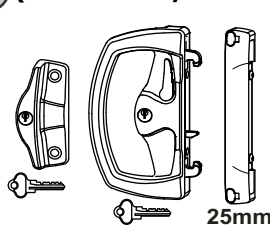
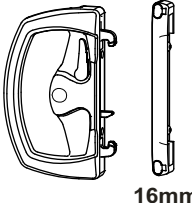
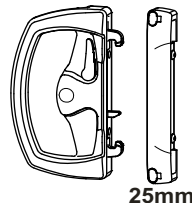
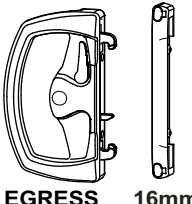
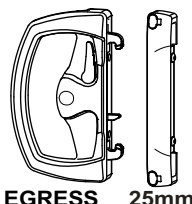
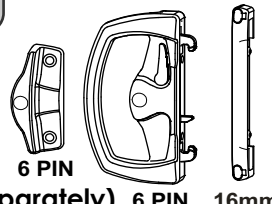
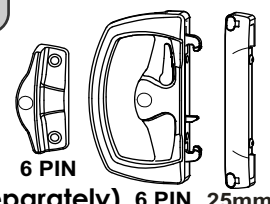
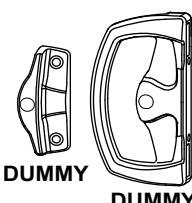

Standard Product Range

	LOCKS WITH 16mm CATCH	LOCKS WITH 25mm CATCH
NO CYLINDERS	YR-AA-AAA-AAA-colour - Standard Outer Pull - Standard "D" Inner Pull - Without cylinders - Narrow 16mm catch (order cylinders separately)  16mm	YR-AA-AAA-BAA-colour - Standard Outer Pull - Standard "D" Inner Pull - Without cylinders - Wide 25mm catch (order cylinders separately)  25mm
	YR-AA-BBB-AAA-colour - Standard Outer Pull - Standard "D" Inner Pull - C4 cylinder in outer pull - Narrow 16mm catch  16mm	YR-AA-BBB-BAA-colour - Standard Outer Pull - Standard "D" Inner Pull - C4 cylinder in outer pull - Wide 25mm catch  25mm
WITH C4 CYLINDERS	YR-AA-DBB-AAA-colour (5 locks keyed alike) YR-AA-DGB-AAA-colour (10 locks keyed alike) - Standard Outer Pull - Standard "D" Inner Pull - C4 cylinders in both pulls - Narrow 16mm catch  16mm	YR-AA-DBB-BAA-colour (5 locks keyed alike) YR-AA-DGB-BAA-colour (10 locks keyed alike) - Standard Outer Pull - Standard "D" Inner Pull - C4 cylinders in both pulls - Wide 25mm catch  25mm
	YR-OA-AAA-AAA-colour - No Outer Pull (order separately) - Standard "D" Inner Pull - Without cylinders - Narrow 16mm catch (order cylinders separately)  16mm	YR-OA-AAA-BAA-colour - No Outer Pull (order separately) - Standard "D" Inner Pull - Without cylinders - Wide 25mm catch (order cylinders separately)  25mm
NO OUTER PULL	YR-OC-AAA-AAA-colour - No Outer Pull (order separately) - Egress "D" Inner Pull - Without cylinders - Narrow 16mm catch (order cylinders separately) EGRESS  16mm	YR-OC-AAA-BAA-colour - No Outer Pull (order separately) - Egress "D" Inner Pull - Without cylinders - Wide 25mm catch (order cylinders separately) EGRESS  25mm
	YR-NN-AAA-AAA-colour - 6-pin Outer Pull - 6-pin "D" Inner Pull - Without cylinders - Narrow 16mm catch (6-pin cylinders ordered separately) 6 PIN  16mm	YR-NN-AAA-BAA-colour - 6-pin Outer Pull - 6-pin "D" Inner Pull - Without cylinders - Wide 25mm catch (6-pin cylinders ordered separately) 6 PIN  25mm
DUMMY	YR-BD-AAA-EAA-colour - Dummy Outer Pull - Dummy "D" Inner Pull - No catch plate (catch plate supplied with pull for non-dummy side of double doors) DUMMY  DUMMY	Non-standard items can be ordered separately (refer to Accessories page for further information) Standard packing is 5 locks per box. Carton size: 290mm x 220mm x 130mm Carton weight approx: 7kg



Multipoint

Vent Lock Multipoint Kit (for aluminium framed doors)

- Provides additional top and bottom locking.
- The door can be locked in two positions; fully closed and with an opening to allow ventilation.
- Bolts are actuated by turning the key.

YR-VL

Vent Lock kit includes:

- 1 x Drive box
- 2 x Drive rods
- 2 x Metal bolts
- 2 x Bolt guides
- 2 x Strike plates
- Fitting bag with fasteners

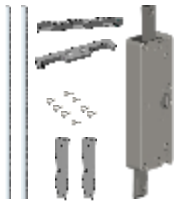

Accessories

YR-6C

Channel mount catch plate.



YR-1C

Mortise outer pull for timber doors (see Timber Door section).



Yarra Cylinders

(compatible with Yarra Ridge pulls)

YC-C4B/ KA or KD

Standard cylinder for Yarra Ridge
5-pin C4 cylinder

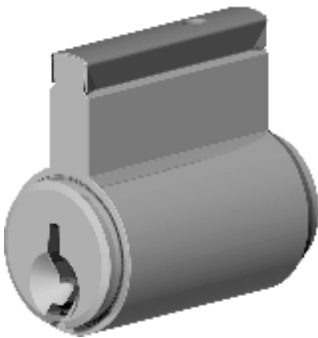

- Re-pinable cylinder
- Project pinning capability

- Master keying available
- Made in Australia

YC-C4B/ KA or KD

Standard 5-pin C4 cylinder

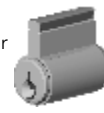

YC-C4A/ KA or KD

5-pin C4 cylinder

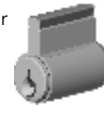

YC-C4C/ KA or KD

Premium 5-pin C4 cylinder



YC-6C4B/ KA or KD

6-pin C4 cylinder

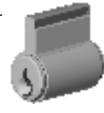

YC-6KIT

6-pin cylinder kit (barrel not included)



YC-GB/ KA or KD

Standard 5-pin G cylinder

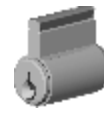

YC-GC/ KA or KD

Premium 5-pin G cylinder



YC-WS/ KA or KD

Wafer cylinder (not suitable for low-profile pulls).



YC-WL/ KA or KD

Wafer cylinder for low-profile pulls.



Ordering Code	Description	Notes
YC-C4B/ KA or KD	Standard 5-pin C4 cylinder	5-pin C4 cylinders
YC-C4A/ KA or KD	5-pin C4 cylinder	
YC-C4C/ KA or KD	Premium 5-pin C4 cylinder	
YC-GB/ KA or KD	Standard 5-pin G cylinder	5-pin G cylinders
YC-GC/ KA or KD	Premium 5-pin G cylinder	
YC-6C4B/ KA or KD	6-pin C4 cylinder	6-pin C4 cylinder
YC-6KIT	6-pin cylinder kit for use with 6-pin restricted barrels (barrel not included)	Restricted 6-pin Kit
YC-WS/ KA or KD	Wafer cylinder (not suitable for low-profile outer pulls)	Wafer cylinders
YC-WL/ KA or KD	Low-profile wafer cylinder (suitable for low-profile outer pulls)	



Standard Outer Pull Options

YR-1A , YR-1N , YR-1B



YR-1A Standard Outer Pull for 5-pin cylinders.
YR-1N Standard Outer Pull for 6-pin cylinders.
YR-1B Outer Pull Dummy no cylinder.

YR-1F



YR-1F Yarra Ridge Outer "D" Pull

YR-1D

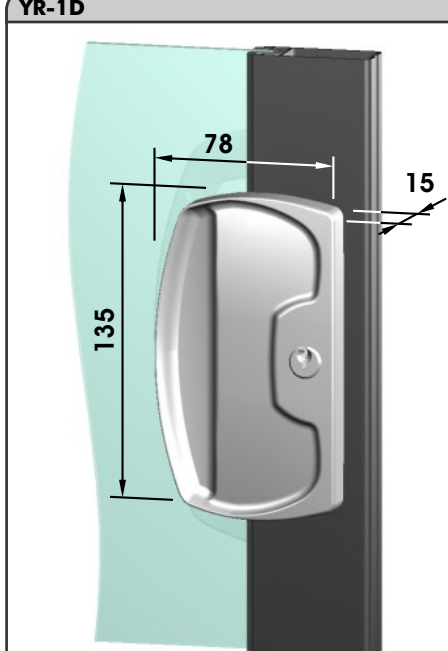

YR-1D Yarra Ridge Flat 15mm Outer Pull suitable for aluminium doors where space between glass sliding door and sliding screen door is limited.

Non-standard Outer Pull Options

for use on specific applications. Please ensure suitability before ordering.

YR-1G

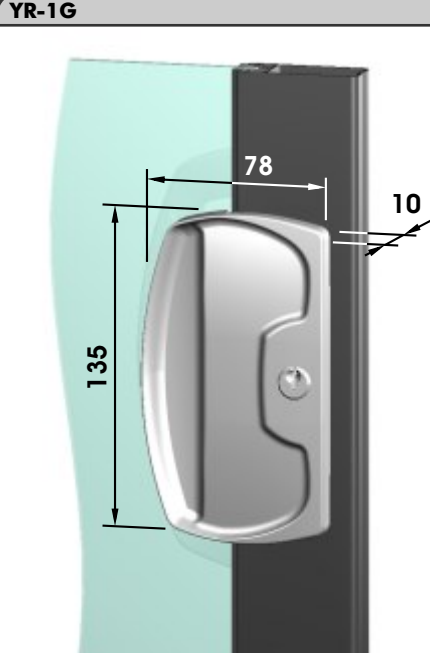

YR-1G Yarra Ridge Flat 10mm Outer Pull suitable for aluminium doors where space between glass sliding door and sliding screen door is limited.

YR-1E

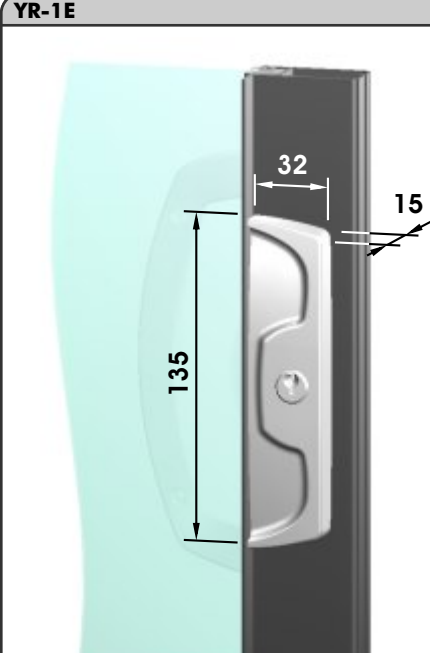

YR-1E Yarra Ridge Flat Narrow 32mm Outer Pull suitable for aluminium doors with stiffening ribs on the door exterior.

YR-1J

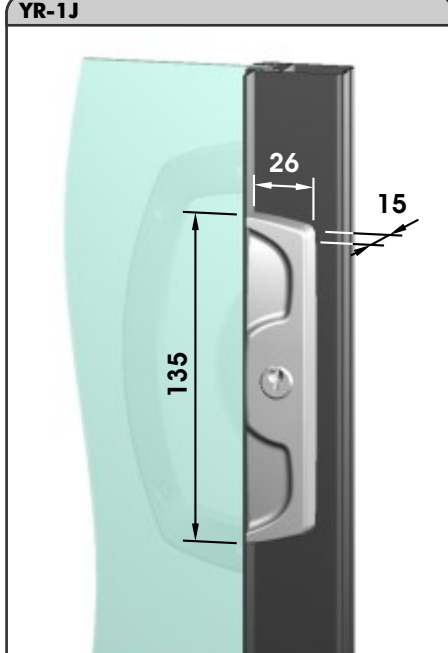

YR-1J Yarra Ridge Flat Narrow 26mm Outer Pull suitable for aluminium doors with stiffening ribs on the door exterior.



Spacers

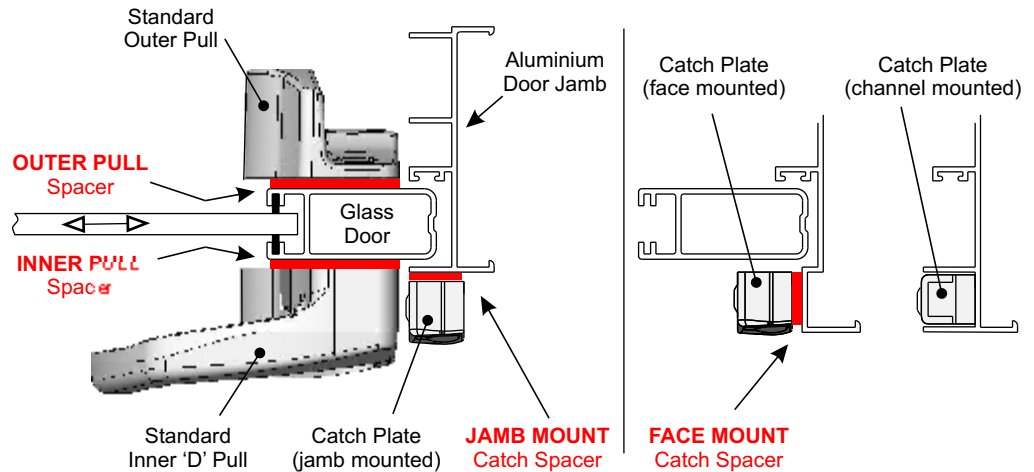

PULL SPACERS	YR-8K	2mm OUTER PULL spacer	
	YR-8L	2mm INNER PULL spacer	
	YR-8N	4mm INNER PULL spacer	
	YR-8J	6mm INNER PULL spacer	
	YR-8E	6mm INNER PULL spacer (x 2) Suitable for: LIDCO DOOR	

CATCH SPACERS	YR-8D	2mm JAMB MOUNT catch spacer Suitable for: WINTEC DOOR	
	YR-8F	2mm JAMB MOUNT catch spacer Suitable for: CRANE OXO DOOR	
	YR-8P	4mm JAMB MOUNT catch spacer	
	YR-8O	2mm FACE MOUNT catch spacer	
	YR-8C	3mm FACE MOUNT catch spacer Suitable for: A&L DOOR and others	

KITS	YR-8B	6mm INNER PULL spacer and 2mm OUTER PULL spacer	
	YR-8G	2mm INNER PULL spacer and 4mm JAMB MOUNT catch spacer	
	YR-8H	6mm INNER PULL spacer and 6mm JAMB MOUNT wide catch spacer	
	YR-8M	4mm INNER PULL spacer and 2mm FACE MOUNT catch spacer	
	YR-8I	6mm INNER PULL 3mm FACE MOUNT 2mm JAMB MOUNT catch spacers	

Ordering Code	Description	Suitable for:	Notes
YR-8K	2mm thick Outer Pull spacer		Pull Spacers
YR-8L	2mm thick Inner Pull spacer		
YR-8N	4mm thick Inner Pull spacer		
YR-8J	6mm thick Inner Pull spacer		
YR-8E	6mm thick Inner Pull spacers (pack of two)	LIDCO doors	
YR-8D	2mm thick Jamb Mount catch spacer	WINTEC doors	Catch Spacers
YR-8F	2mm thick Jamb Mount catch spacer	CRANE OXO doors	
YR-8P	4mm thick Jamb Mount catch spacer		
YR-8O	2mm thick Face Mount catch spacer		
YR-8C	3mm thick Face Mount catch spacer	A&L doors and others	Spacer Kits
YR-8B	6mm thick Inner Pull spacer + 2mm Outer Pull spacer	CAPRAL 889 doors	
YR-8G	2mm thick Inner Pull spacer + 4mm Jamb Mount catch spacer	CRANE OXO doors	
YR-8H	6mm thick Inner Pull spacer + 6mm Jamb Mount wide catch spacer		
YR-8M	4mm thick Inner Pull spacer + 2mm Face Mount catch spacer	MICOS sliding suite	
YR-8I	6mm thick Inner Pull spacer + 3mm Face catch + 2mm Jamb catch spacer	ALSPEC FITZROY door	